

# ABLOY® CAMLOCKS

*Expertise at your service*





## ABLOY® EXPERTISE AT YOUR SERVICE

**ABLOY®** cam locks have been developed to meet the highest levels of security in the field of equipment locking. Our extensive range consists of both standard products and a wide selection of customised products. The superior benefits offered by **ABLOY®** cam locks make them ideally suited to the most demanding, high security applications where valuables are located either behind small doors or in enclosures, e.g. vending machines, cash dispensers, gaming machines, parking meters, pay phones, coin-operated laundry machines etc. Our long experience in high security products and our high levels of expertise guarantee you the best possible choice for your particular application.



## HIGH-SECURITY PERFECTION

The unique **ABLOY®** cylinder construction, patented cylinders, strict key control and extensive masterkeying capabilities make **ABLOY®** cam locks ideally suited for the most demanding applications.

Only the correct key can align the gates on all the discs and permit the locking bar to disengage the cylinder from the housing.

cylinder from the housing.  
the locking bar to disengage the  
gates on all the discs and permit



### Unique construction

Based on a unique operating principle which employs rotating detainer discs, **ABLOY®** cam locks offer advantages that other locking systems cannot achieve.

### Virtually pickproof

The **ABLOY®** PROTEC cylinder employs a new, patented disc blocking system (DBS) which makes it impossible to manipulate the cylinder so that it opens without the correct key.

### Physical strength

**ABLOY®** cam locks combine excellence in design with the very latest engineering and production technology. Additional resistance to physical attacks is ensured by the use of case-hardened steel components.

### Masterkeying capabilities

Based on a unique operating principle which employs rotating detainer discs, **ABLOY®** cam locks offer advantages that other locking systems cannot achieve.

### Resistance to harsh conditions

The **ABLOY®** cylinder contains no springs or pins which could cause it to malfunction in a wide range of environmental conditions. All the components are highly resistant to wear, dirt, moisture, corrosion or freezing conditions.

### User-friendly

The disc control system and symmetrical key make **ABLOY®** cam locks easy to operate.



## PATENTED CYLINDER TECHNOLOGIES

These patented **ABLOY®** cylinders feature symmetrical keys and disc steering system that provides smooth, reliable operation. Both **ABLOY® SENTRY** and **ABLOY® PROTEC** have specialized features which make them ideally suited for particular applications.



### **ABLOY® SENTRY**

- Nickel-silver key with heavy duty polymer key bow
- Patented key, key blank and cylinder construction
- Particularly suitable for industrial locking systems
- Exceptional picking and environmental resistance

### **ABLOY® PROTEC**

- All metal key, nickel-silver
- Patented key, key blank and cylinder construction
- Disc blocking system (DBS), virtually pickproof
- Can be masterkeyed with doorlock cylinders
- Extensive range of **ABLOY®** industrial locks available

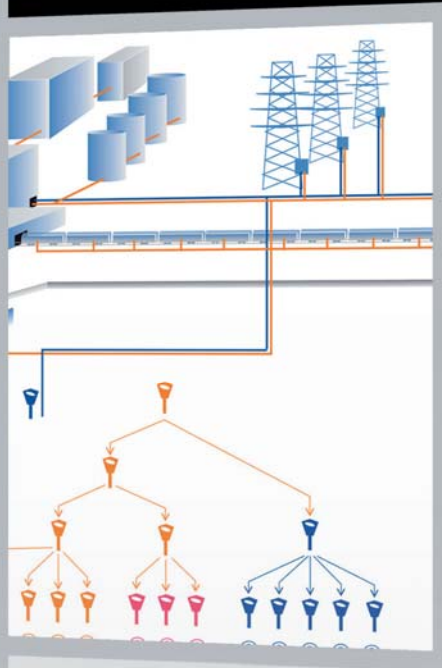

## KEY SECURITY

To guarantee maximum customer security **ABLOY**® cylinder system offers a variety of key profiles and patented key security levels with a factory-controlled key service.

### Customer level

Exclusive keyways for applications where the highest level of key security is required.

### Factory level

The supply of keys is controlled by either the **ABLOY**® factory or an **ABLOY**® sales office

### Authorised **ABLOY**® dealer level

Keys are supplied by an **ABLOY**® authorised security centre under contract.



## CUSTOMISED PERFECTION

Decades of experience in creating locking solutions for the most demanding applications has given us a clear understanding of the need for customisation in design, operation and levels of security.

Working in close co-operation with our customers, we are dedicated to the search for no-compromise solutions which are a perfect match for your application. Your operational environment and functional requirements form the basis for a design process which ensures that the solutions developed will be easy to use and add significant value to your equipment.

All **ABLOY**® locks are designed and produced using the latest manufacturing technology, guaranteeing high quality, rapid response and reliable delivery



## PROTECTION IN EVERY FIELD

The extensive range of **ABLOY**<sup>®</sup> cam locks includes locks in a variety of sizes, which feature different modes of operation, making them ideally suited to a wide range of applications. We offer cam locks to fit almost any size, thickness or type of metal or wooden doors in universal and US dimensional specifications.

### Worldwide references

The most demanding security institutions and industries have trusted **ABLOY**<sup>®</sup> locks since 1907. Thousands of manufacturers in numerous countries have chosen **ABLOY**<sup>®</sup> locks to secure their high-quality products, such as

- vending machines
- parking meters
- safe deposits
- gaming machines
- museum showcases
- mobile phone base stations
- transport containers
- switch cabinets
- rifles
- pay phones

# THE RIGHT PRODUCT FOR EVERY APPLICATION

Model		Cam turns: key removable		Material of cylinder housing	Number of discs	Left hand operation possible	Cylinder type *)		
Dimensions	Product numbers	90° /180° In locked position only	360° In locked and unlocked pos.				C	B	N
UNIVERSAL RANGE		CL100 (3275C) CL101 (3276C)	●	●	brass brass	11 11	●	●	●
		CL103 (3277C, 3507D) CL106 (3278C)	●	●	brass brass	11 11	●	●	●
		CL104 (3273C, 3504D) CL105 (3243C, 3505D) CL107 (3274C)	● ●	●	brass steel brass	9 9 9	●	●	●
		CL108 CL109	● ●		brass brass	7 7	● ●		●
		CL110	●		steel	9	●		●
US RANGE		CL200 (3373C, 3506D) CL201 (3503D)	● ●		brass steel	9 9	● ●	●	●
		CL202 (3377C)	●		brass	11	●	●	●
		CL203 (3375C)	●		brass	11	●	●	●
		CL204 CL205 (3343C)	● ●		steel steel	9 9	● ●	●	●

= UL listed products

= Patented cylinder systems

\*) C= **ABLOY® CLASSIC**, B= **ABLOY® SENTRY**, N= **ABLOY® PROTEC**



# ABLOY® KEY OPERATED SWITCH LOCKS EP400, EP401, EP402

## Dimensions

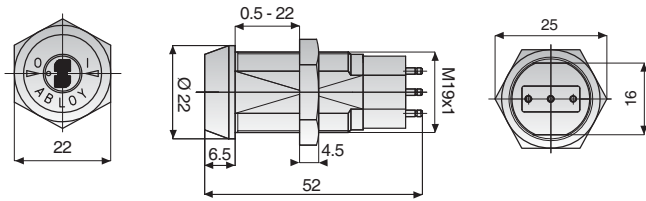

## Circuit diagram

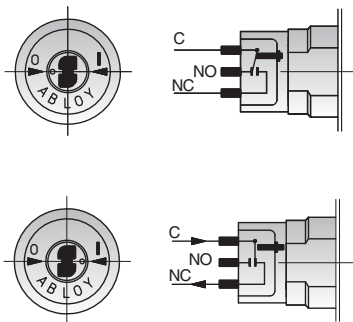

C = common  
 NO = normally open  
 NC = normally closed

**ABLOY®** switch locks provide key-actuated switching for burglar alarms, control boxes and other high security applications.

The locks are available in three different models:

- EP400: key removable in “on” and “off” positions
- EP401: key removable in “off” position
- EP402: momentary-contact key removable in “off” position

Locks can be fitted on panels from 0.5 mm to 22 mm thick.

**Microswitch:** Honeywell 1SX1-H58 for contacting with AMP 0.058 inch (1.47 mm) reseatables

**Electrical specifications:** 7A, 250 VAC  
 7A res., 28 VDC  
 4A ind., 28 VDC

**Operational range:** -54° to +120 °C

**Cylinder types:** C, N

### Material and finish:

- Cylinder housing: chrome-plated brass
- Hex nut: zinc-plated steel
- Coupling piece and switch mounting plug: molded plastic
- Other parts: brass
- Number of discs: 11

# ABLOY® T-HANDLE LOCKS CL290, 291

## Dimensions

### CL290

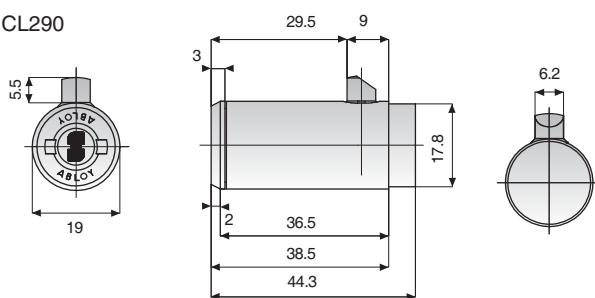

### CL291

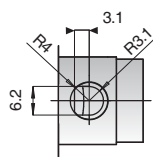
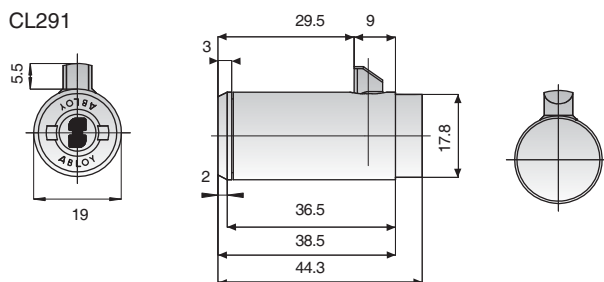

**ABLOY®** T-handle locks are ideal for vending machines and other locking handle applications. Steel bolt provides maximum resistance against attack by pulling.

The locks are available in two different models:

- CL290: spring-loaded latch
- CL291: deadlocking latch

**Cylinder types:** C, B, N

### Material and finish:

- Cylinder housing: chrome-plated steel
- Cylinder face: case-hardened chrome-plated steel
- Latch: nickel-plated steel
- Other parts: brass, stainless steel, tin bronze
- Number of discs: 9

## CAM TURNS

Locked position

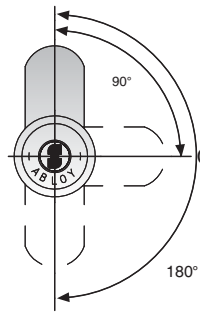

Open position

Open position

Locked position

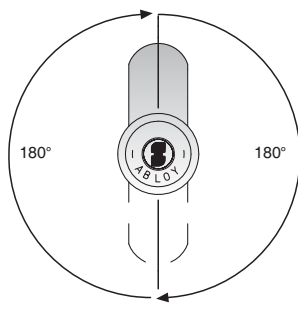

Open position

Open position

### LOCK TYPES

CL100    CL200  
CL103    CL201  
CL104    CL202  
CL105    CL203  
CL108    CL204  
CL109    CL205  
CL110

### LOCK TYPES

CL101  
CL106  
CL107

## UNIVERSAL AND US SPECIFICATIONS

Universal specification



Cylinder face

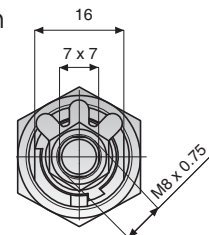

Cylinder end

Us specification



Cylinder face

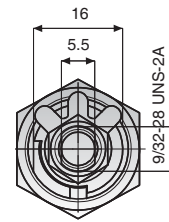

Cylinder end

## CONSTRUCTION AND FINISH

Brass cylinder (two vertical marks on cylinder face)



- Detainer discs: Tin bronze
- Cylinder drum and end nut: Brass
- Cam, governor, nut lock washer and hex nut: Zinc-plated steel
- Cylinder housing: Chrome-plated brass

Steel cylinder (two horizontal marks on cylinder face)



- Detainer discs: Tin bronze
- Cylinder drum and end nut: Brass
- Cam, governor, nut lock washer and hex nut: Zinc-plated steel
- Cylinder housing: Case-hardened, chrome-plated steel

## DIMENSIONS OF FITTING HOLE

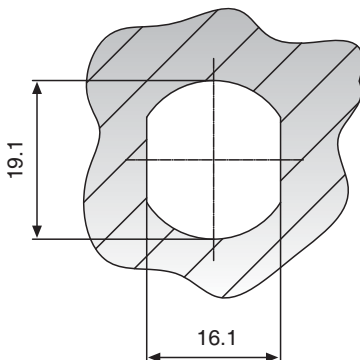

## WHEN ORDERING, PLEASE SPECIFY

- Lock type
- Cylinder type
  - C = **ABLOY**® CLASSIC
  - B = **ABLOY**® SENTRY
  - N = **ABLOY**® PROTEC
- Number of keys in (to be ordered separately). In other cylinder types 2 keys/lock included.
- Key profile
- Finish of the cylinder housing, if not standard (chrome)
  - M = brass
  - H = satin chrome
- Cam type, if required (see page 11)
- Cam turn (90o, 180o)
- Fitting plate, if required

# CAMS

For cam locks in the universal range, three different cam models available: straight, hooked and oset. Cams are made of nickel-plated steel. Cams for the US range of cam locks are available in the US sales office.

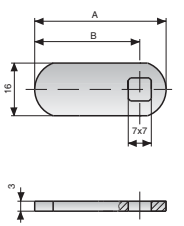
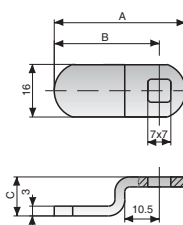
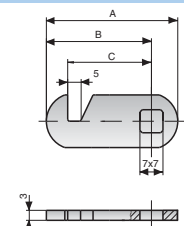
Straight cam	Part No.	A	B	Offset cam	Part No.	A	B	C	
	455608	26	18		455678	32	24	13.3	
	434815	30.5	22.5		434959	33	25	26.5	
	434869	33	25		455333	35	27	5	
	455322	35	27		434928	35	27	6.5	
	434609	38	30		455499	35	27	9.5	
	434794	40	32		455525	35	27	10.5	
	455556	45	37		434816	36	28	12	
	455548	48	40		434799	36	28	22	
	455494	53	45		455557	37	29	18.5	
	455797	58	50		434766	38	30	15	
455606	68	60	434667	38	30	7			
	Hooked cam	Part No.	A	B	C	435097	40	32	5
	455514	31	23	16.5	434702	40	32	19	
	434605	32	24	17.5	434635	45	37	5	
	455332	35	27	20.5	434700	45	37	8	
	455492	42.5	34.5	28	434852	45	37	13.3	
	434818	47.5	39.5	33	434757	48	40	19	
	455780	58	50	43.5	434788	50	42	12.5	
	455549	60.5	52.5	46	455461	61	53	18	

## FITTING PLATES

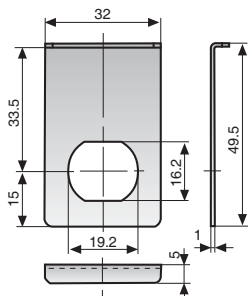

413807

- For use with plastic ring 4841003 in glass doors.
- Available also with brass finish, product number 413808
- Material: Chrome-plated steel

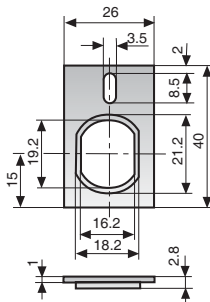

455328

- Used inside of a wooden door to prevent the lock from rotating
- Fixed by screws through the upper holes of the plate
- Material: Zinc-plated steel

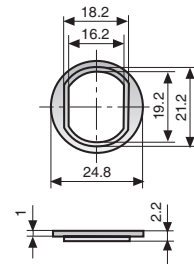

434613

- Used mostly as replacement for cam locks of universal specifications
- Normally used on both sides of the mounting hole
- Material: Zinc-plated steel

## SPECIAL ACCESSORIES

Special accessories are made of chrome-plated steel.

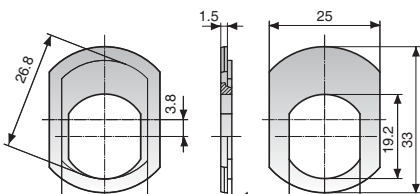

Fitting plate 441345

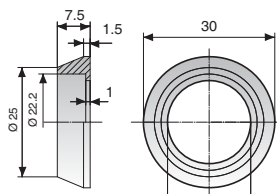

Protective collar 804757

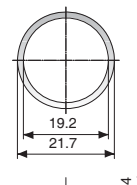

Lifting sleeve 804252

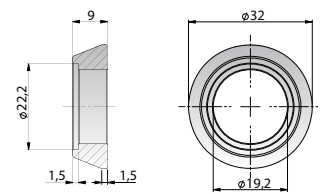

Lifting sleeve 817260

## ABLOY® – the sign for security



The quality and environmental systems used by Abloy Oy guarantee that customers can be certain of **ABLOY®** quality in every field. We received our first Quality System Certificate - SFS-EN ISO 9001 - in 1989. Just eight years later, Abloy Oy was one of the first companies in Finland to be granted an SFS-EN-ISO 14001 Environmental System Certificate.

Our products are designed and manufactured not only to provide high levels of security, but also to be reliable, user-friendly and aesthetically pleasing. **ABLOY®** is your sign for security.

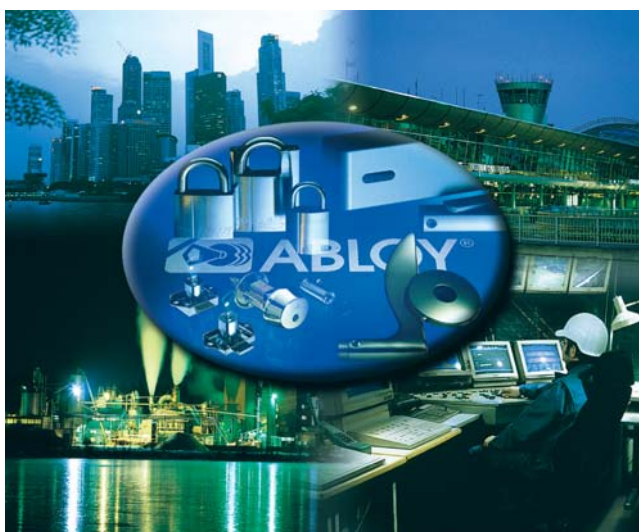

**ABLOY®** is a registered trademark of Abloy Oy, one of the leading manufacturers of locks, locking systems and architectural hardware and the world's leading developer of products in the field of electromechanical lock technology.

The unique **ABLOY®** detainer disc cylinder mechanism has several advantages over conventional locking mechanisms. Ever since its invention in 1907, it has been a symbol of high security and superior performance.

Our range consists of electromechanical locks, cam locks, padlocks, office furniture locks, rim locks, lock cases, cylinders for different types of mortice locks, door closers, door automatics and architectural hardware. **ABLOY®** locking solutions for every application are available from our world-wide network of distributors.

Customer-oriented development, combined with our long experience and extensive security expertise, mean that **ABLOY®** security solutions employ the very latest technology to meet your needs.



[www.abloy.com](http://www.abloy.com)

Abloy Oy  
Wahlforssinkatu 20  
P.O.Box 108  
FI-80101 JOENSUU  
FINLAND  
Tel. +358 20 599 2501  
Fax +358 20 599 2209

